



**XM Sound System**  
User Guide



# About XM

XM is America's number one satellite radio company. Broadcasting live daily from studios in Washington, DC, New York City, Chicago, the Country Music Hall of Fame in Nashville, Toronto and Montreal, XM's lineup includes more than 170 digital channels of choice from coast to coast: commercial-free music, premier sports, news, talk radio, comedy, children's and entertainment programming; and the most advanced traffic and weather information.

XM is the leader in satellite-delivered entertainment and data services for the automobile market through partnerships with General Motors, Honda, Hyundai, Nissan, Porsche, Subaru, Suzuki and Toyota. XM's industry-leading products are available at consumer electronics retailers nationwide. For more information about XM hardware, programming and partnerships, please visit <http://www.xmradio.com/>.

# Table of Contents

Getting Started . . . . .	4
Step 1: Unpack the XM Sound System . . . . .	4
Step 2: Choose your Radio-specific dock adapter . . . . .	5
Step 3: Insert your radio . . . . .	7
Step 4: Install the antenna . . . . .	8
Step 5: Install the power . . . . .	9
Step 6: Turn it on . . . . .	11
Step 7: Listen . . . . .	12
Taking Care of Your XM Sound System . . . . .	14
Troubleshooting . . . . .	15
Technical information . . . . .	16
FCC and IC Statement . . . . .	17
Warranty . . . . .	18

# Getting Started

## **Congratulations, you've just expanded the use of your XM Radio!**

Now, in addition to listening to the channels you love in the car, you can listen to XM radio in your home or on the go.

Use these instructions to set up your XM Sound System. If you need help, call XM Support at 1-800-XM-RADIO (1-800-967-2346) or contact us at [www.xmradio.com](http://www.xmradio.com).

### **Step 1: Unpack the XM Sound System**



XM home antenna

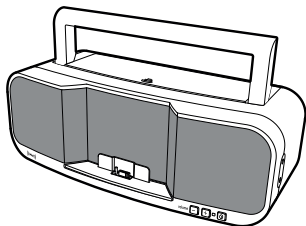

XM sound system

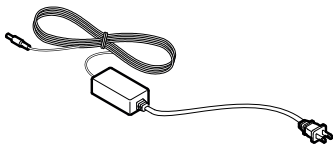

Power supply

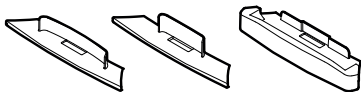

Radio-specific dock adapters

## Step 2: Choose your Radio-specific dock adapter

The Xpress dock adapter is already installed in the Sound System for the Audiovox Xpress, Audiovox XpressEZ, Audiovox XpressR, or Audiovox XpressRC.

If you are not using an Xpress radio, you must replace the Xpress dock adapter with the appropriate one for your XM radio.

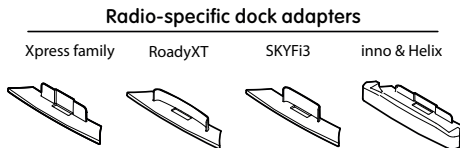

- 1 To remove the Xpress dock adapter, lift both sides of the adapter at the same time.
- 2 Insert the dock adapter for your radio.

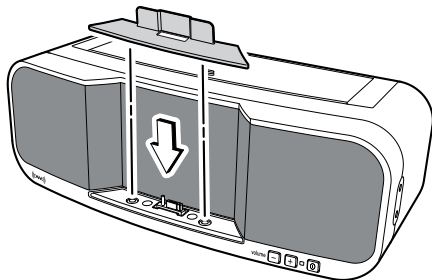

# Getting Started

If your radio is a Pioneer inno™ or a Samsung Helix™, you will also need the *XM2go Boombox Adapter XMPA1* (sold separately). After installing the dock adapter, plug the special *XM2go Boombox Adapter* into place.

## Adapter for the inno and Helix

---

inno / Helix

*XM2go Boombox Adapter  
XMPA1*  
\*Sold separately

Included inno/Helix  
Dock Adapter

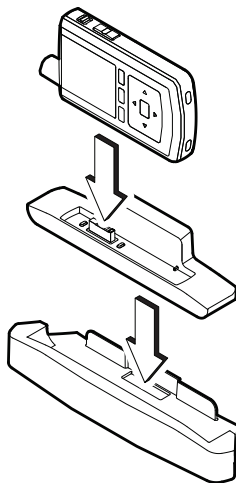

### Step 3: Insert your radio

To insert your XM Radio into the Sound System, align the radio's connector with the Sound System's connector, then carefully but firmly press to secure the radio in place.

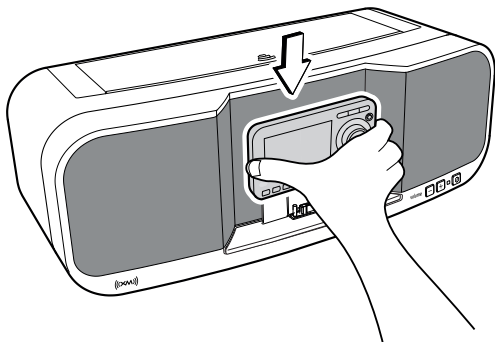

**TIP!** Although designed to fit snugly, we recommend that you remove the radio before moving the Sound System.

# Getting Started

## Step 4: Install the antenna

- 1 Place the antenna:
  - At home, place the antenna near a south-facing window.
  - On the go, position the antenna for best reception.
- 2 Remove the battery cover.

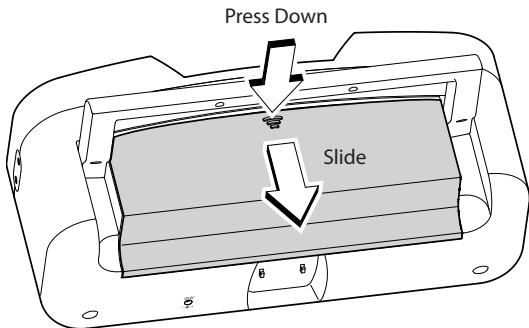



- 3 Plug the antenna into the jack labeled Antenna.



**TIP!** Wrap any excess antenna cable around the hooks, it is best to wrap it counter clockwise. It is best to wrap counter clockwise starting with the plug end of the cable.

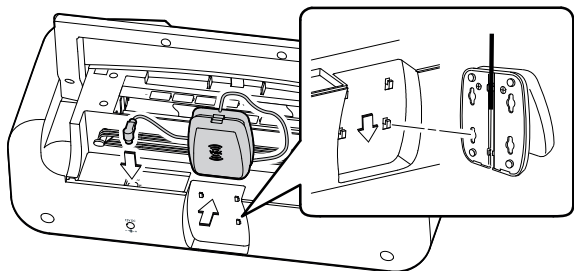

## Step 5: Install the power

To use your Sound System on the go:

- 1 Insert 8 C batteries (sold separately).

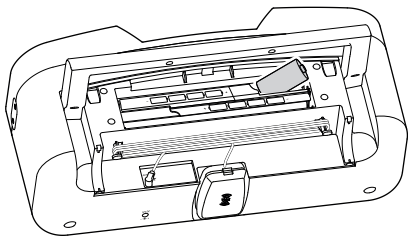

# Getting Started

- 2 Replace battery cover.

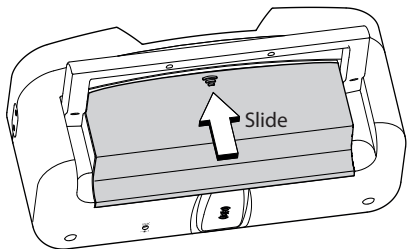

**TIP!** When the battery life is getting low the power LED will blink and your XM Radio may not play music.



**TIP!** It is not recommended to retain batteries in the Sound System for an **extended length** of time. Remove batteries when not in use.

- 1 Plug the AC power adapter into the jack labeled 12V DC on the Sound System.
- 2 Plug the other end into any 110-120V power source

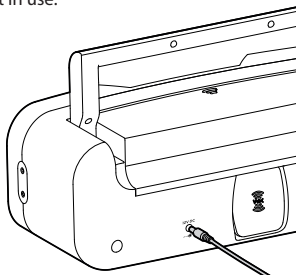

## Step 6: Turn it on

- 1 Press the power button on the Sound System.
- 2 Turn on your XM Radio.

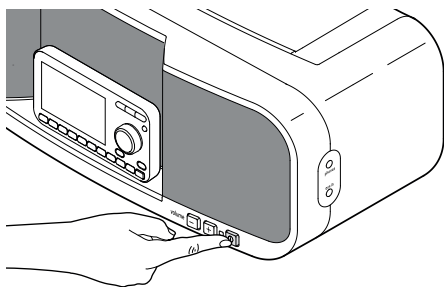

**TIP!** For some radio models, you can enable the Auto-ON feature for ease of use. Refer to your radio's menu settings and User Guide for instructions. The Helix and inno need to be powered down manually.



**TIP!** The Helix and inno will charge while in the sound system, turn off the sound system if you do not want your Helix or inno to charge.



**TIP!** If both batteries and the power adapter are connected, the Sound System will operate on AC power. Unplug the Sound System when not in use.

# Getting Started

## Step 7: Listen

- 1 Operate your XM Radio according to its User Guide.
- 2 Use the volume buttons on the Sound System to adjust the sound level
- 3 Use the XM Radio to adjust the bass and treble settings.
- 4 If available, to control both your XM radio and Sound System, use the remote that came with your XM Radio
- 5 If desired, plug in your headphones to the phones jack. Use the volume buttons on the Sound System to control the headphones. The Sound System's speakers are muted when the headphones are in use.

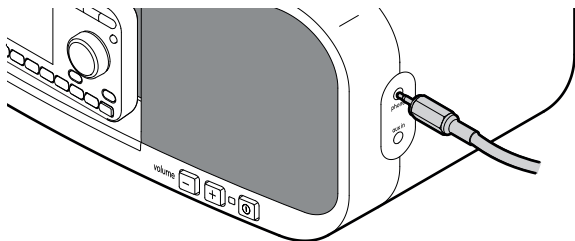

- 6 Your Sound System contains an aux in jack so you can connect other devices such as CD or MP3 players via a mini audio cable (sold separately).

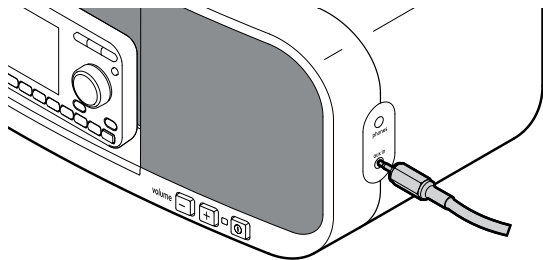

# Taking Care of Your Sound System

## Placement

Do not place the Sound System or XM radio near heat sources or in direct sunlight. Do not place the Sound System on an inclined or unstable surface, in areas of excessive dust, or areas prone to mechanical shock. Do not block the speakers or ventilation ports.

Because the speakers contain powerful magnets, keep credit cards, mechanical watches, and other devices that might be affected away from the Sound System.

## Cleaning



**DANGER!** Unplug the AC power adapter and/or remove the batteries during the cleaning to avoid any electrical shock hazard.

Clean the hard surfaces of the Sound System with a soft cloth slightly moistened with a mild detergent solution.

Clean the soft surfaces of the speakers with a dry lint brush.

Do not use any type of abrasive pad, scouring powder, or solvent, such as alcohol or benzene.



## If this happens

## Try this

My XM radio is not receiving a signal.	Use the “antenna aiming” feature on the XM radio and move the antenna to another location.
My XM radio will not turn on.	Check whether the power cord is plugged into the wall. Ensure batteries are fresh and inserted correctly. If applicable, make sure Auto-ON is enabled.
I only receive XM channels 0 and 1.	Make sure your radio is activated. Contact XM at <a href="http://www.xmradio.com">www.xmradio.com</a> or 1-800-XM-RADIO.
The radio and Sound System are on and receiving a signal but I can't hear anything.	Remove the radio from the Sound System and re-insert it, then turn the power on. Unplug any headphones. Check the volume control. Make sure “MUTE” is not set on the remote if used. If the power LED is blinking change the batteries.
I hear noise or interference.	Move away from any cordless telephones or electrical appliances or other devices that may cause interference.
My remote doesn't work.	Make sure that the IR sensors are not obstructed. It may be time to replace the battery in the remote.

# Technical Information

---

## Dimensions

XM Sound System	405mm(W) X 147mm(H) X 184mm(D) 16 in(W) X 5.78 in(H) X 7.24 in (D)
Adapter	49mm(W) X 78mm(H) X 35mm(D) 1.92 in (W) X 3.07 in(H) X 1.37 in(D)

---

## Weight

XM Audio System	3.345 Kg	7.375 lbs
Adapter	0.142 Kg	0.3125 lbs

---

## Inputs and Outputs

XM antenna input	1SMB connector
Aux In	3.5mm diameter mini stereo jack
Headphone output	3.5 mm diameter mini stereo jack

---

## Power

DC	Normal 12V (6-16V), positive polarity, (+ inner conductor),
Battery (sold separately)	8 C cell alkaline or rechargeable

---

## Temperature

Operating	-25°C ~ 70°C	-13°F ~ 158°F
Storage	-40°C ~ 70°C	-40°F ~ 158°F

---

## Audio

Power	Maximum 5W RMS per channel at 1% THD at DC12V power supply (power output is reduced when the power supply is less than 12V.)
Frequency response	100Hz ~ 20KHz @ +/- 3dB

---

## Suitable Receivers (sold separately)

Audiovox Xpress	Audiovox XpressEZ
Audiovox XpressR	Audiovox XpressRC
Delphi RoadyXT®	Delphi SKYFi3®
Pioneer inno™ (with XM2go Boombox Adapter)	Samsung Helix™ (with XM2go Boombox Adapter)



# FCC and IC Statement

## FCC and IC Statement

The user is cautioned that changes or modifications not expressly approved by XM Satellite Radio Inc. can void the user's authority to operate this device.

This device has been designed to operate with the antenna provided in the original packaging. Use of antenna other than the antenna provided will result in improper operation, and is strictly prohibited per regulations of Industry Canada.

This device complies with Part 15 of the FCC Rules and is certified to Industry Canada's RSS-210 specification:

1. This device may not cause harmful interference.
2. This device must accept any interference received, including interference that may cause undesired operation.

This equipment has been tested and found to comply with the limits for a Class B digital device, pursuant to Part 15 of the FCC Rules and Industry Canada RSS-210. These limits are designed to provide reasonable protection against harmful interference in a residential installation.

This equipment generates, uses, and can radiate radio frequency energy and, if not installed and used in accordance with the installation instructions, may cause harmful interference to radio communications. However, there is no guarantee that interference will not occur in a particular installation. If this equipment does cause harmful interference to radio or television reception, which can be determined by turning the equipment off and on, the user is encouraged to try to correct the interference by one or more of the following measures:

- Reorient or relocate the receiving antenna of the affected receiver.
- Increase the separation between the XM equipment and the affected receiver.
- Connect the XM equipment into an outlet on a circuit different from that to which the affected receiver is connected.
- Consult the dealer or an experienced radio/TV technician for help.

**WARNING!** The FCC and FAA have not certified this Satellite Radio Receiver for use in any aircraft (neither portable nor permanent installation). Therefore, XM Satellite Radio cannot support this type of application or installation.

# Warranty



**AUDIOVOX®**

## **12 Month Limited Warranty**

AUDIOVOX ELECTRONICS CORPORATION (the Company) warrants to the original retail purchaser of this product that should under normal use and conditions, be proven defective in material or workmanship within 12 months from the date of original purchase, such defect(s) will be repaired or replaced with new or reconditioned product (at the Company's option) without charge for parts and repair labor.

To obtain repair or replacement within the terms of this Warranty, the product is to be delivered with proof of warranty coverage (e.g. dated bill of sale), specification of defect(s), transportation prepaid, to an approved warranty station or the Company at the address shown on the next page.

This Warranty does not extend to the elimination of externally generated static or noise, damage to speakers from extended play at excessive volumes, malfunction of satellite transmissions, repeater signal or receiver unit.

This Warranty does not apply to any product in the opinion of the Company that has been damaged through alteration, improper installation, mishandling, misuse, neglect, accident, or by removal or defacement of the factory serial number/bar code label(s).

THE EXTENT OF THE COMPANY'S LIABILITY UNDER THIS WARRANTY IS LIMITED TO THE REPAIR OR REPLACEMENT PROVIDED ABOVE AND, IN NO EVENT, SHALL THE COMPANY'S LIABILITY EXCEED THE PURCHASE PRICE PAID BY PURCHASER FOR THE PRODUCT.

This Warranty is in lieu of all other express warranties or liabilities. ANY IMPLIED WARRANTIES, INCLUDING ANY IMPLIED WARRANTY OF MERCHANTABILITY, SHALL BE LIMITED TO THE DURATION OF THIS WRITTEN WARRANTY. ANY ACTION FOR BREACH OF ANY WARRANTY HEREUNDER MUST BE BROUGHT WITHIN 24 MONTHS FROM DATE OF ORIGINAL PURCHASE. IN NO CASE SHALL THE COMPANY BE LIABLE FOR ANY CONSEQUENTIAL OR INCIDENTAL DAMAGES FOR BREACH OF THIS OR ANY OTHER WARRANTY. No person or representative is authorized to assume for the Company any liability other than expressed herein in connection with the sale of this product.

Some states do not allow limitations on how long an implied warranty lasts or the exclusion or limitation of incidental or consequential damage so the above limitations or exclusions may not apply to you. This Warranty gives you specific legal rights and you may also have other rights which vary from state to state.

U.S.A. : AUDIOVOX ELECTRONICS CORPORATION, 150 MARCUS BLVD., HAUPPAUGE, NEW YORK 11788 1-800-645-4994

CANADA : CALL 1-800-645-4994 FOR LOCATION OF WARRANTY STATION SERVING YOUR AREA



XMBB1

Audiovox Electronics Corporation  
150 Marcus Blvd.  
Hauppauge, New York 11788  
U.S.A.  
1 800 645 4994

[www.audiovox.com](http://www.audiovox.com)

XM name and related logos are registered trademarks of XM Satellite Radio Inc.  
All other trademarks are property of their respective owners.

©2007 Audiovox Electronics Corporation. All rights reserved.